

TIRANT SUR SABLIERE 1/20

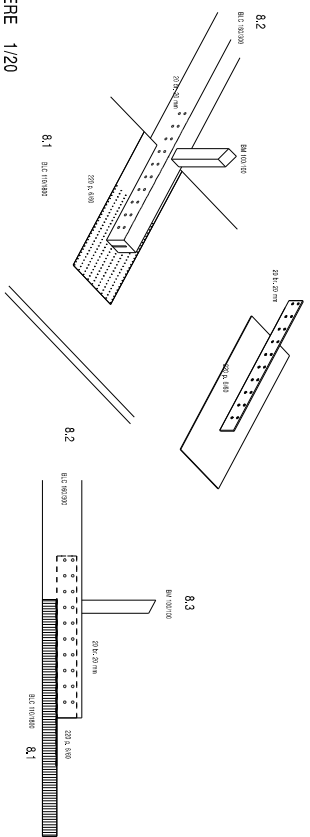

APPUI ARC SUR SABLIERE 1/20

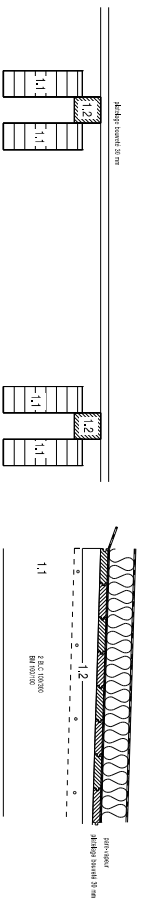
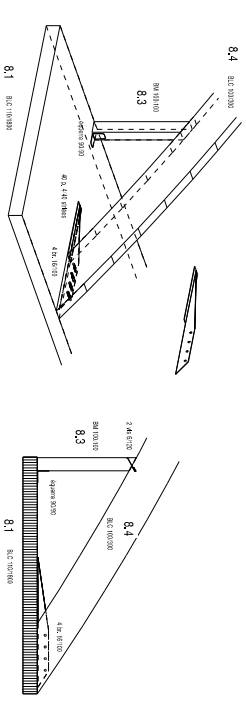

10.1 COMPLEXE DE TOITURE COUPANT 1/10

DETAIL DE SOMMET D'ARC

10.2 COMPLEXE DE TOITURE COUPANT 1/10

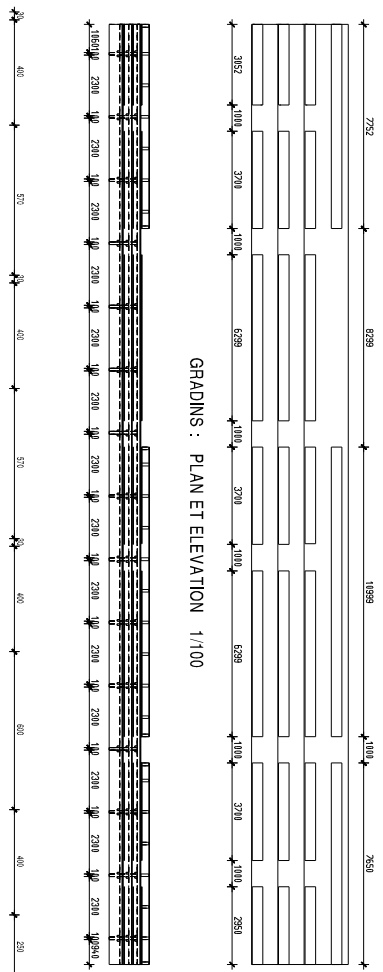
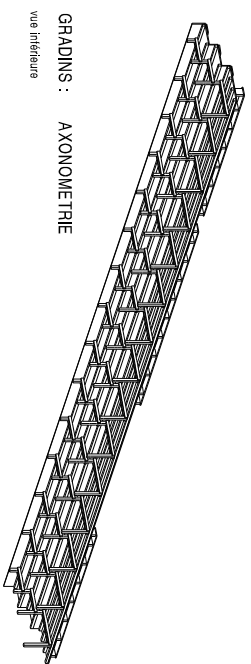
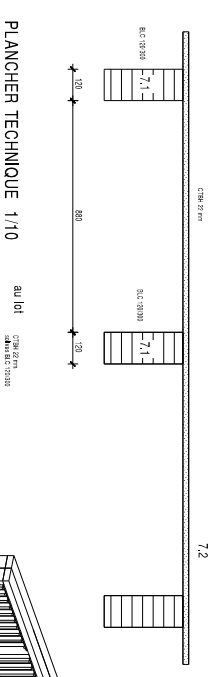
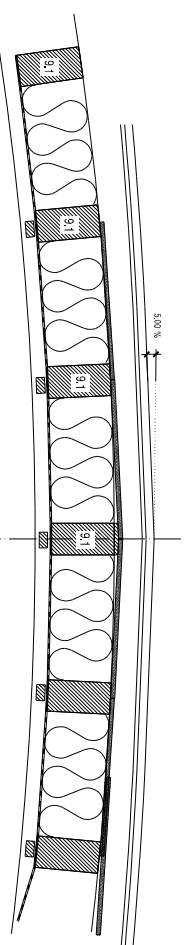
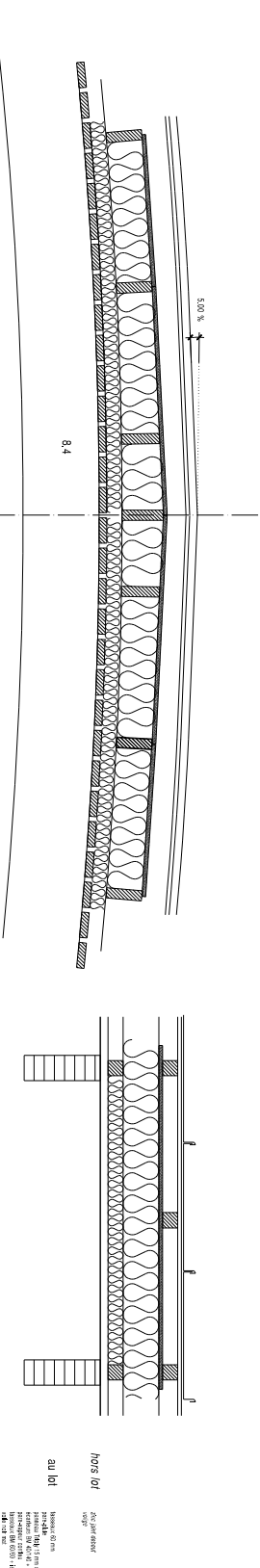

GRADINS : COUPE 1/10

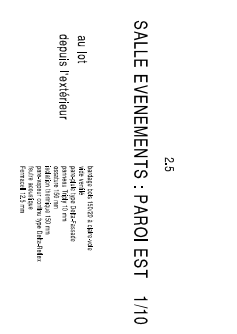
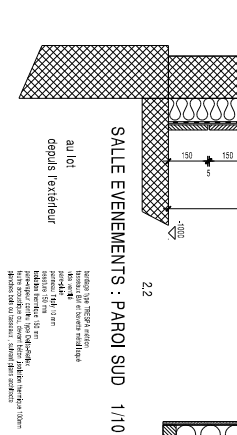
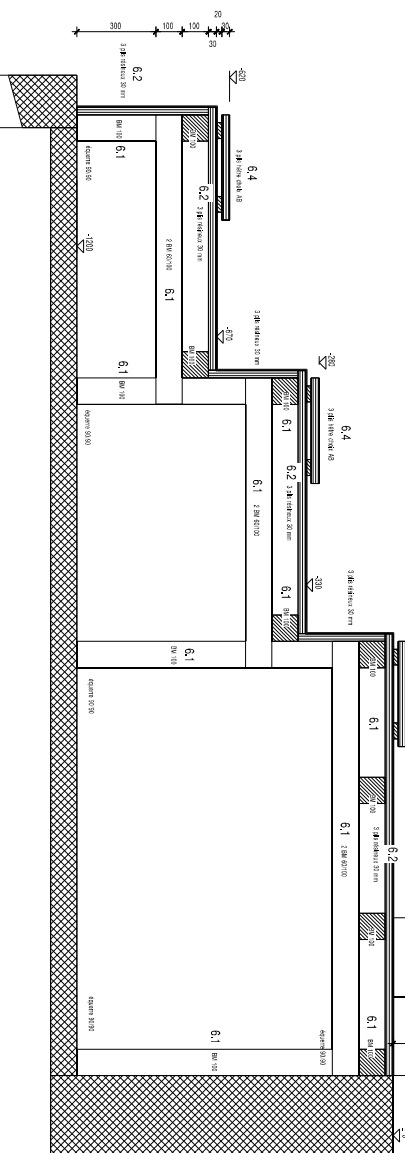

CADRE BOIS DEVANT SALLE DE REUNION 1/20

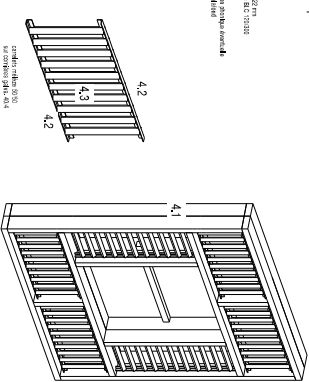
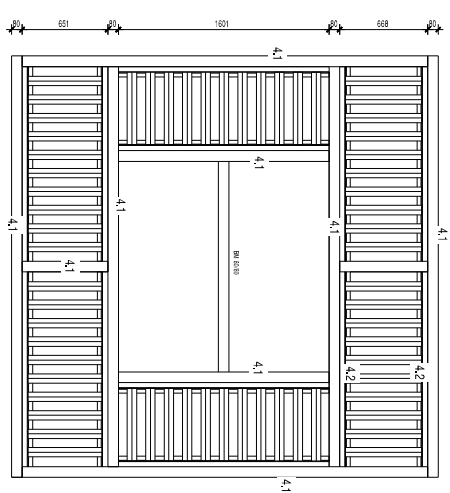

NON ADRESSEES 3000 BOURG 44000 NANTES FRANCE 02 51 18 40 00 02 51 18 40 01 02 51 18 40 02 02 51 18 40 03 02 51 18 40 04 02 51 18 40 05 02 51 18 40 06 02 51 18 40 07 02 51 18 40 08 02 51 18 40 09 02 51 18 40 10 02 51 18 40 11 02 51 18 40 12 02 51 18 40 13 02 51 18 40 14 02 51 18 40 15 02 51 18 40 16 02 51 18 40 17 02 51 18 40 18 02 51 18 40 19 02 51 18 40 20 02 51 18 40 21 02 51 18 40 22 02 51 18 40 23 02 51 18 40 24 02 51 18 40 25 02 51 18 40 26 02 51 18 40 27 02 51 18 40 28 02 51 18 40 29 02 51 18 40 30 02 51 18 40 31 02 51 18 40 32 02 51 18 40 33 02 51 18 40 34 02 51 18 40 35 02 51 18 40 36 02 51 18 40 37 02 51 18 40 38 02 51 18 40 39 02 51 18 40 40 02 51 18 40 41 02 51 18 40 42 02 51 18 40 43 02 51 18 40 44 02 51 18 40 45 02 51 18 40 46 02 51 18 40 47 02 51 18 40 48 02 51 18 40 49 02 51 18 40 50 02 51 18 40 51 02 51 18 40 52 02 51 18 40 53 02 51 18 40 54 02 51 18 40 55 02 51 18 40 56 02 51 18 40 57 02 51 18 40 58 02 51 18 40 59 02 51 18 40 60 02 51 18 40 61 02 51 18 40 62 02 51 18 40 63 02 51 18 40 64 02 51 18 40 65 02 51 18 40 66 02 51 18 40 67 02 51 18 40 68 02 51 18 40 69 02 51 18 40 70 02 51 18 40 71 02 51 18 40 72 02 51 18 40 73 02 51 18 40 74 02 51 18 40 75 02 51 18 40 76 02 51 18 40 77 02 51 18 40 78 02 51 18 40 79 02 51 18 40 80 02 51 18 40 81 02 51 18 40 82 02 51 18 40 83 02 51 18 40 84 02 51 18 40 85 02 51 18 40 86 02 51 18 40 87 02 51 18 40 88 02 51 18 40 89 02 51 18 40 90 02 51 18 40 91 02 51 18 40 92 02 51 18 40 93 02 51 18 40 94 02 51 18 40 95 02 51 18 40 96 02 51 18 40 97 02 51 18 40 98 02 51 18 40 99 02 51 18 40 100	VORION (38) Pôle de sports de combat LOT CHARENTAIS - DCE DETAILS COMPLEXES ENCHÈRE N° 22118 22/10/2018
--	--

STB 04